

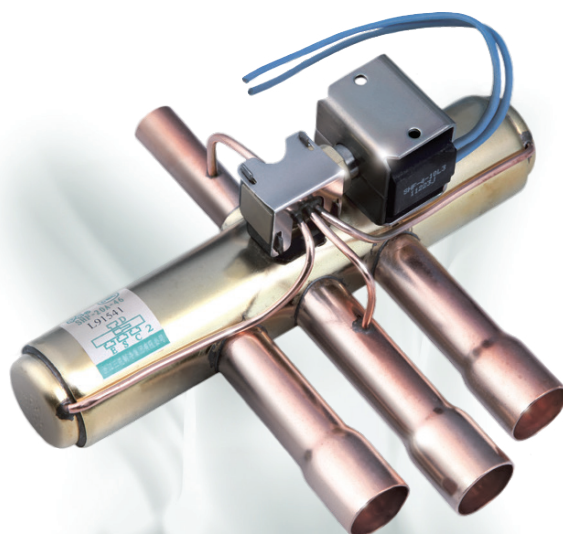

4 Way Reversing Valve

SHF series four-way reversing valves are applicable for heat pump systems such as central, unitary and room air conditioners to realize switching between cooling mode and heating mode by changing the flow path of refrigerant.



FEATURES

- WIDE APPLICATION RANGE
- SUITABLE FOR COOLING CAPACITIES FROM 3 TO 240 KW (0,9 TO 69 TONS)
- SEVERAL DESIGNS AVAILABLE

GENERAL SPECIFICATIONS

- Applicable for all common HCFC and HFC refrigerants such as: R22, R134a, R404A, R407C, R410A, R507
- Min./max. ambient temperature: -25°C to +70°C
- PS: 4,2 MPa
- TS min./max.: -30°C / +120°C
- Relative humidity below 95%
- Certifications: PED & UL, VDE

NOMINAL OPERATING CONDITIONS

Nominal operating conditions	Condition 1:	Condition 2:
Condensing Temperature t _c	38°C	54,4°C
Evaporating Temperature t _o	5°C	7,2°C
SuperHeating dt _{oh}	5K	5K
SubCooling dt _u	0K	5K

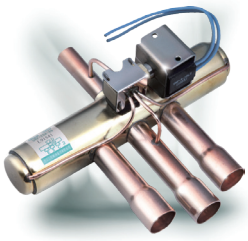

SANHUA SHF SERIES 4 Way Reversing Valve

GENERAL CHARACTERISTICS

Model	Part Number	Port	Kv Factor	Connections Size ODF		PS	Operating Pressure Difference ΔP		PED category
				D-tube	E/S/C Tube		MAX	MIN	
		[mm]	[m3/h]	\emptyset [in]	\emptyset [in]	[MPa]	[MPa]	[MPa]	
SHF(L)-4H-23U	SHF-19001	8,0	1,6	5/16	3/8	4,2	3,1	0,25	3,3
SHF(L)-7H-34U	SHF-19002	11,1	2,9	3/8	1/2	4,2	3,1	0,25	3,3
SHF(L)-9H-35U	SHF-19003	11,5	3	3/8	5/8	4,2	3,1	0,34	3,3
SHF(L)-11H-45D1	SHF-19004	11,5	3,2	1/2	5/8	4,2	3,1	0,34	3,3
SHF-14-46	SHF-50001	13,5	6,4	1/2	3/4	4,2	3,1	0,34	3,3
SHF-14-47	SHF-50002	13,5	6,4	1/2	7/8	4,2	3,1	0,34	3,3
SHF-14-57	SHF-50003	13,5	6,4	5/8	7/8	4,2	3,1	0,34	3,3
SHF-20A-46-02	SHF-50004	15,6	7,4	1/2	3/4	4,2	3,1	0,34	3,3
SHF-20A-47	SHF-50005	15,6	7,4	1/2	7/8	4,2	3,1	0,34	3,3
SHF-20A-57	SHF-50006	15,6	7,4	5/8	7/8	4,2	3,1	0,34	3,3
SHF-20A-67	SHF-50007	15,6	7,4	3/4	7/8	4,2	3,1	0,34	3,3
SHF-20D-46-02	SHF-50008	17,2	9,5	1/2	3/4	4,2	3,1	0,34	3,3
SHF-35A-47	SHF-50009	20,0	12,4	1/2	7/8	4,2	3,1	0,34	3,3
SHF-35A-57	SHF-50010	20,0	12,4	5/8	7/8	4,2	3,1	0,34	3,3
SHF-35A-59	SHF-50011	20,0	12,4	5/8	9/8	4,2	3,1	0,34	3,3
SHF-35A-67	SHF-50012	20,0	12,4	3/4	7/8	4,2	3,1	0,34	3,3
SHF-35A-69	SHF-50013	20,0	12,4	3/4	9/8	4,2	3,1	0,34	3,3
SHF-35A-79	SHF-50014	20,0	12,4	7/8	9/8	4,2	3,1	0,34	3,3
SHF-35B-67-02	SHF-50015	20,9	13,7	3/4	7/8	4,2	3,1	0,34	3,3
SHF-50-911D2	SHF-50016	25,6	13,8	1-1/8	1-3/8	4,2	3,1	0,34	I
SHF(L)-70-810	SHF-50017	28,6	28,8	1	1-1/4	4,2	3,1	0,34	I
SHF(L)-100-1012	SHF-50018	34,8	39,3	1-1/4	1-1/2	4,2	3,1	0,34	I
SHF(L)-140-1214	SHF-50019	41,0	58,3	1-1/2	1-3/4	4,2	3,1	0,34	I
SHF(L)-175-1217	SHF-50020	46,4	70,3	1-1/2	2-1/8	4,2	3,1	0,34	I
SHF(L)-210-1321	SHF-50021	50,0	79,7	1-5/8	2-5/8	4,2	3,1	0,34	I

DS-SHF-EN-R1209 Copyright © SANHUA 2012 Subject to change without notice



CHILLING IDEAS WORLDWIDE

SANHUA INTERNATIONAL EUROPE
sanhuaeurope.com

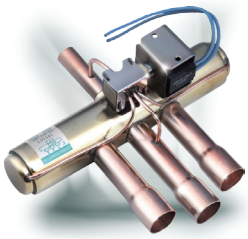

SANHUA SHF SERIES 4 Way Reversing Valve

CAPACITY SELECTION

Model	Part Number	Nominal Capacity (condition 1)							
		R407C		R410A		R134a		R404A / R507	
		$\Delta P:$ 0,1 bar	$\Delta P:$ 0,2 bar	$\Delta P:$ 0,1 bar	$\Delta P:$ 0,2 bar	$\Delta P:$ 0,1 bar	$\Delta P:$ 0,2 bar	$\Delta P:$ 0,1 bar	$\Delta P:$ 0,2 bar
		[kW]	[kW]	[kW]	[kW]	[kW]	[kW]	[kW]	[kW]
SHF(L)-4H-23U	SHF-19001	3,3	4,6	3,9	5,4	2,4	3,5	2,4	3,5
SHF(L)-7H-34U	SHF-19002	5,7	8,1	6,7	9,5	4,3	6,0	4,3	6
SHF(L)-9H-35U	SHF-19003	7,3	10,4	8,7	12,2	5,5	7,8	5,5	7,8
SHF(L)-11H-45D1	SHF-19004	9,0	12,7	10,6	14,9	6,7	9,5	6,7	9,5
SHF-14-46	SHF-50001	11,4	16,1	13,5	19,0	8,6	12,1	8,6	12,1
SHF-14-47	SHF-50002	11,4	16,1	13,5	19,0	8,6	12,1	8,6	12,1
SHF-14-57	SHF-50003	11,4	16,1	13,5	19,0	8,6	12,1	8,6	12,1
SHF-20A-46	SHF-50004	16,3	23,0	19,3	27,2	12,2	17,3	12,2	17,3
SHF-20A-47	SHF-50005	16,3	23,0	19,3	27,2	12,2	17,3	12,2	17,3
SHF-20A-57	SHF-50006	16,3	23,0	19,3	27,2	12,2	17,3	12,2	17,3
SHF-20A-67	SHF-50007	16,3	23,0	19,3	27,2	12,2	17,3	12,2	17,3
SHF-20D-46-02	SHF-50008	19,1	27,0	22,6	31,8	14,3	20,2	14,3	20,2
SHF-35A-47	SHF-50009	28,6	40,3	33,7	47,5	21,4	30,2	21,4	30,2
SHF-35A-57	SHF-50010	28,6	40,3	33,7	47,5	21,4	30,2	21,4	30,2
SHF-35A-59	SHF-50011	28,6	40,3	33,7	47,5	21,4	30,2	21,4	30,2
SHF-35A-67	SHF-50012	28,6	40,3	33,7	47,5	21,4	30,2	21,4	30,2
SHF-35A-69	SHF-50013	28,6	40,3	33,7	47,5	21,4	30,2	21,4	30,2
SHF-35A-79	SHF-50014	28,6	40,3	33,7	47,5	21,4	30,2	21,4	30,2
SHF-35B-67-02	SHF-50015	28,6	40,3	33,7	47,5	21,4	30,2	21,4	30,2
SHF-50-911D2	SHF-50016	29	40,9	34,2	48,3	21,8	30,7	21,8	30,7
SHF(L)-70-810	SHF-50017	57,1	80,6	67,4	95,1	42,9	60,4	42,9	60,4
SHF(L)-100-1012	SHF-50018	81,6	115,1	96,3	135,8	61,2	86,3	61,2	86,3
SHF(L)-140-1214	SHF-50019	114,3	161,1	134,9	190,1	85,7	120,9	85,7	120,9
SHF(L)-175-1217	SHF-50020	142,9	201,4	168,6	237,7	107,1	151,1	107,1	151,1
SHF(L)-210-1321	SHF-50021	171,4	241,7	202,3	285,2	128,6	181,3	128,6	181,3

DS-SHF-EN-R1209 Copyright © SANHUA 2012 Subject to change without notice



CHILLING IDEAS WORLDWIDE

SANHUA INTERNATIONAL EUROPE
sanhuaeurope.com

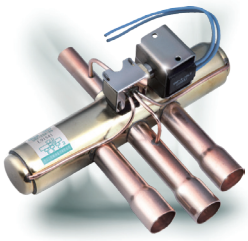

SANHUA SHF SERIES 4 Way Reversing Valve

CAPACITY SELECTION

Model	Part Number	Nominal Capacity (condition 2)							
		R407C		R410A		R134a		R404A / R507	
		$\Delta P:$ 0,1 bar	$\Delta P:$ 0,2 bar	$\Delta P:$ 0,1 bar	$\Delta P:$ 0,2 bar	$\Delta P:$ 0,1 bar	$\Delta P:$ 0,2 bar	$\Delta P:$ 0,1 bar	$\Delta P:$ 0,2 bar
		[kW]	[kW]	[kW]	[kW]	[kW]	[kW]	[kW]	[kW]
SHF(L)-4H-23U	SHF-19001	3,0	4,3	3,6	5,0	2,3	3,2	2,3	3,2
SHF(L)-7H-34U	SHF-19002	5,3	7,5	6,2	8,8	4,0	5,6	4,0	5,6
SHF(L)-9H-35U	SHF-19003	6,8	9,6	8,0	11,3	5,1	7,2	5,1	7,2
SHF(L)-11H-45D1	SHF-19004	8,3	11,7	9,8	13,8	6,2	8,8	6,2	8,8
SHF-14-46	SHF-50001	10,6	14,9	12,5	17,6	7,9	11,2	7,9	11,2
SHF-14-47	SHF-50002	10,6	14,9	12,5	17,6	7,9	11,2	7,9	11,2
SHF-14-57	SHF-50003	10,6	14,9	12,5	17,6	7,9	11,2	7,9	11,2
SHF-20A-46	SHF-50004	15,1	21,3	17,8	25,2	11,3	16,0	11,3	16,0
SHF-20A-47	SHF-50005	15,1	21,3	17,8	25,2	11,3	16,0	11,3	16,0
SHF-20A-57	SHF-50006	15,1	21,3	17,8	25,2	11,3	16,0	11,3	16,0
SHF-20A-67	SHF-50007	15,1	21,3	17,8	25,2	11,3	16,0	11,3	16,0
SHF-20D-46-02	SHF-50008	17,7	25,0	20,9	29,5	13,3	18,7	13,3	18,7
SHF-35A-47	SHF-50009	26,5	37,3	31,2	44,0	19,8	28,0	19,8	28,0
SHF-35A-57	SHF-50010	26,5	37,3	31,2	44,0	19,8	28,0	19,8	28,0
SHF-35A-59	SHF-50011	26,5	37,3	31,2	44,0	19,8	28,0	19,8	28,0
SHF-35A-67	SHF-50012	26,5	37,3	31,2	44,0	19,8	28,0	19,8	28,0
SHF-35A-69	SHF-50013	26,5	37,3	31,2	44,0	19,8	28,0	19,8	28,0
SHF-35A-79	SHF-50014	26,5	37,3	31,2	44,0	19,8	28,0	19,8	28,0
SHF-35B-67-02	SHF-50015	26,5	37,3	31,2	44,0	19,8	28,0	19,8	28,0
SHF-50-911D2	SHF-50016	26,9	37,9	31,7	44,7	20,1	28,4	20,1	28,4
SHF(L)-70-810	SHF-50017	52,9	74,6	62,4	88,0	39,7	56,0	39,7	56,0
SHF(L)-100-1012	SHF-50018	75,6	106,6	89,2	125,8	56,7	79,9	56,7	79,9
SHF(L)-140-1214	SHF-50019	105,8	149,2	124,9	176,1	79,4	111,9	79,4	111,9
SHF(L)-175-1217	SHF-50020	132,3	186,5	156,1	220,1	99,2	139,9	99,2	139,9
SHF(L)-210-1321	SHF-50021	158,7	223,8	187,3	264,1	119,0	167,9	119,0	167,9

DS-SHF-EN-R1209 Copyright © SANHUA 2012 Subject to change without notice



CHILLING IDEAS WORLDWIDE

SANHUA INTERNATIONAL EUROPE
sanhuaeurope.com

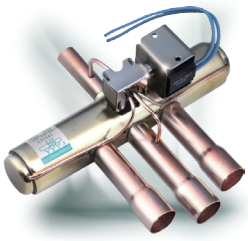

SANHUA SHF SERIES 4 Way Reversing Valve

DIMENSIONS

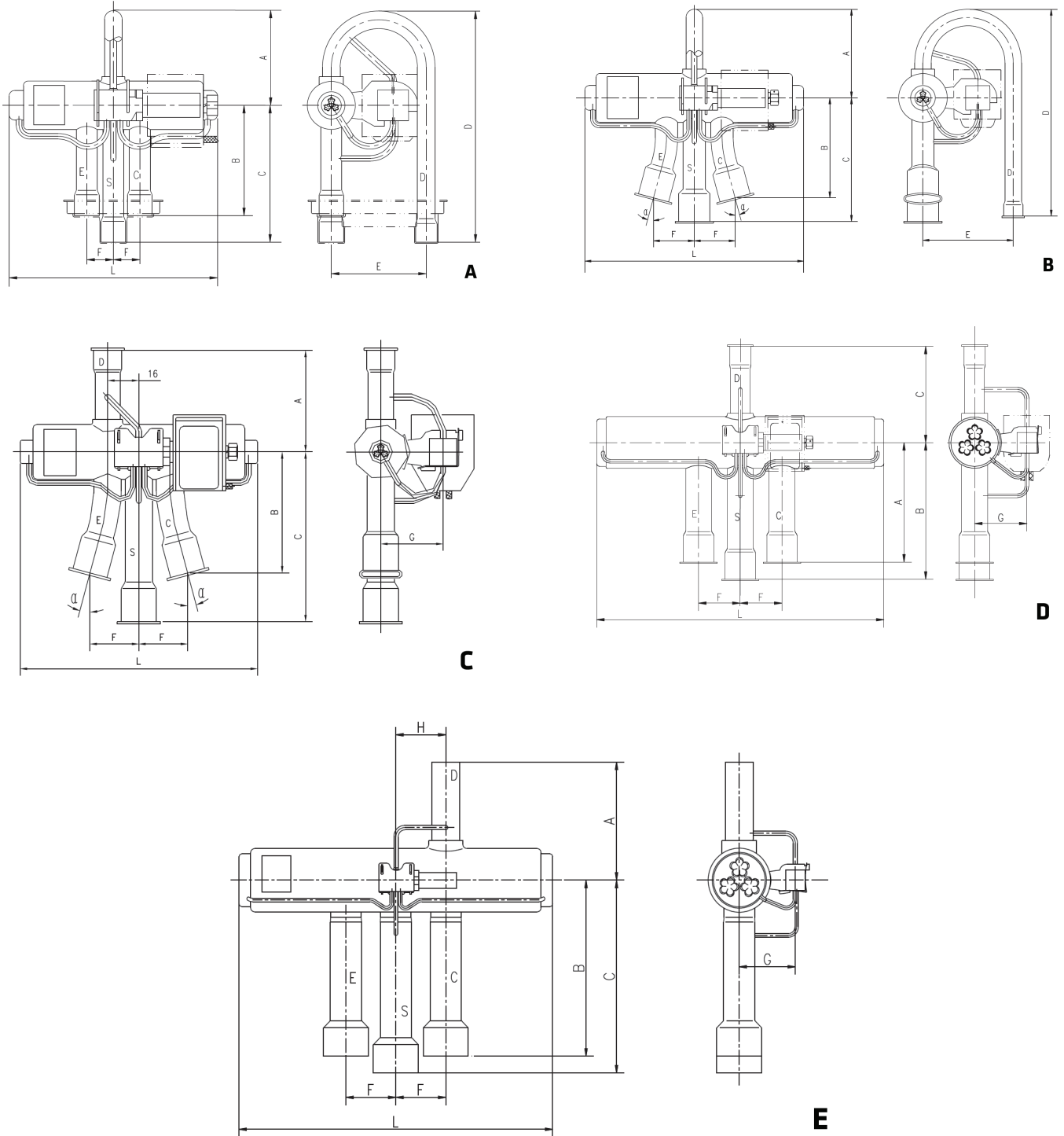

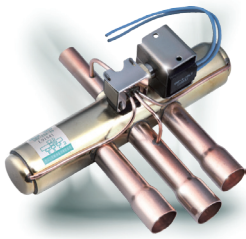

SANHUA SHF SERIES 4 Way Reversing Valve

DIMENSIONS

Model	Part Number	Valve Style	L	A	B	C	D	E	F	G	H	Angle α	Reference Weight
			[mm]	[mm]	[mm]	[mm]	[mm]	[mm]	[mm]	[mm]	[mm]	[mm]	[°]
SHF(L)-4H-23U	SHF-19001	A	94,4	43	50	62	105	43	12	-	-	0	0,20
SHF(L)-7H-34U	SHF-19002	A	113	51	59	71	119	52	16	-	-	0	0,28
SHF(L)-9H-35U	SHF-19003	B	115,5	51	57	72	119	52	23,5	-	-	15	0,30
SHF(L)-11H-45D1	SHF-19004	C	121,5	52	62	87	-	-	25	31,5	-	15	0,32
SHF-14-46	SHF-50001	D	184,2	67	83	95	-	-	28,6	35,5	-	0	0,72
SHF-14-47	SHF-50002	D	184,2	67	83	95	-	-	28,6	35,5	-	0	0,72
SHF-14-57	SHF-50003	D	184,2	67	83	95	-	-	28,6	35,5	-	0	0,72
SHF-20A-46	SHF-50004	D	176	67	83	95	-	-	28,6	35,5	-	0	0,75
SHF-20A-47	SHF-50005	D	176	67	83	95	-	-	28,6	35,5	-	0	0,75
SHF-20A-57	SHF-50006	D	176	67	83	95	-	-	28,6	35,5	-	0	0,75
SHF-20A-67	SHF-50007	D	176	67	83	95	-	-	28,6	35,5	-	0	0,75
SHF-20D-46-02	SHF-50008	D	183,6	67	83	95	-	-	28,6	35,5	-	0	0,75
SHF-35A-47	SHF-50009	D	211	82	87	100	-	-	33	40	-	0	1,30
SHF-35A-57	SHF-50010	D	211	82	87	100	-	-	33	40	-	0	1,30
SHF-35A-59	SHF-50011	D	211	82	87	100	-	-	33	40	-	0	1,30
SHF-35A-67	SHF-50012	D	211	82	87	100	-	-	33	40	-	0	1,30
SHF-35A-69	SHF-50013	D	211	82	87	100	-	-	33	40	-	0	1,30
SHF-35A-79	SHF-50014	D	211	82	87	100	-	-	33	40	-	0	1,30
SHF-35B-67-02	SHF-50015	D	213	82	87	100	-	-	33	40	-	0	1,30
SHF-50-911D2	SHF-50016	E	269	97	149	174			41,3	40	41,3	0	2,10
SHF(L)-70-810	SHF-50017	D	303	111,8	117	131			46	86		0	3,00
SHF(L)-100-1012	SHF-50018	D	321	111,8	117	131			49	86		0	3,50
SHF(L)-140-1214	SHF-50019	D	390	135,6	148,7	168,7			58	97		0	7,20
SHF(L)-175-1217	SHF-50020	D	390	135,6	148,7	168,7			58	97		0	7,60
SHF(L)-210-1321	SHF-50021	D	452	135,6	148,7	168,7			71,5	97		0	8,70

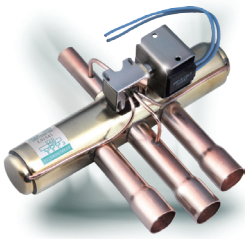

SANHUA SHF SERIES 4 Way Reversing Valve

COIL CHARACTERISTICS

Model	Part Number	Electrical function / connection Type	Cable Length	Power Supply	Rated Voltage	Power Consumption			Protection Grade	Insulation class	Max working temp.
						AC 50Hz	AC 60Hz	DC			
						[mm]	[-]	[V]			
SHF-4-10L3	SHF-56001	Lead Wires	500	AC	220 to 240	4,5	3,5	-	IP54	B	130
SHF-4-10L2	SHF-56002	Lead Wires	500	AC	200	4,5	3,5	-	IP54	B	130
SHF-4-10L1	SHF-56003	Lead Wires	500	AC	100	4,5	3,5	-	IP54	B	130
SHF-4-10L4	SHF-56004	Lead Wires	500	AC	110 to 120	4,5	3,5	-	IP54	B	130
SHF-4-10L5	SHF-56005	Lead Wires	500	AC	24	4,5	3,5	-	IP54	B	130
SHF-4-10L6	SHF-56006	Lead Wires	500	AC	265 to 277	4,5	3,5	-	IP54	B	130
SHF-4-10W11	SHF-56007	Lead Wires	500	AC	220	6	5	-	IP54	B	130
SHF-4-10W12	SHF-56008	Lead Wires	500	AC	220 to 240	6	5	-	IP54	B	130
SHF-4-10W13	SHF-56009	Lead Wires	500	AC	100	6	5	-	IP54	B	130
SHF-4-10W14	SHF-56010	Lead Wires	500	AC	200	6	5	-	IP54	B	130
SHF-4-10WD2	SHF-56011	Lead Wires	500	DC	35	-	-	7	IP54	B	130
SHF-4-10FA5	SHF-56012	Spade Conn. (Faston)	-	AC	220 to 240	6	5	-	IP00	F	155
SHF-4-10FA1	SHF-56013	Spade Conn. (Faston)	-	AC	220	6	5	-	IP00	F	155
SHF-4-10FA2	SHF-56014	Spade Conn. (Faston)	-	AC	115 to 120	6	5	-	IP00	F	155
SHF-4-10FA3	SHF-56015	Spade Conn. (Faston)	-	AC	100 to 110	6	5	-	IP00	F	155
SHF-4-10FA4	SHF-56016	Spade Conn. (Faston)	-	AC	24	6	5	-	IP00	F	155
SHF-4-10FA6	SHF-56017	Spade Conn. (Faston)	-	AC	265 to 277	6	5	-	IP00	F	155
SHF-4-10FA7	SHF-56018	Spade Conn. (Faston)	-	AC	200	6	5	-	IP00	F	155
SHF-4-10FA8	SHF-56019	Spade Conn. (Faston)	-	DC	12	-	-	10	IP00	F	155
SHF-4-10FA9	SHF-56020	Spade Conn. (Faston)	-	DC	24	-	-	11	IP00	F	155
SQ-A27100-010001	SHF-56021	Bistable / Lead Wires	500	AC	100	18	18	-	IP54	B	130
SQ-A27200-010001	SHF-56022	Bistable / Lead Wires	500	AC	200	18	18	-	IP54	B	130
SQ-D27012-010001	SHF-56023	Bistable / Lead Wires	500	DC	12	-	-	20	IP54	B	130